

## SCOTTY CEILING

OLIGO Lichttechnik GmbH  
Tannenweg 1  
DE - 53757 Sankt Augustin  
Germany  
www.oligo.de  
info@oligo.de







Art.-Nr. / Item-No.  
**41-859-XX-YY**

Dieses Produkt enthält Lichtquelle/n des Typs Seoul Semiconductors, SMJE-3D12W4PE der Energieeffizienzklasse F.

(D)	Leuchtmittel nicht ersetzbar
(GB)	Bulbs not replaceable
(NL)	Lamp niet vervangbaar
(F)	Ampoules non remplaçables
(I)	Lampadina non sostituibile
(ES)	Bombillas no reemplazables
(P)	Lâmpada não substituível
(DK)	Ljuskällorna kan inte bytas ut

(S)	Bulb inte utbytbara
(N)	Lyspærer kan ikke skiftes ut
(FI)	Valistusvälinettä ei voi vaihtaa
(TR)	Ampuller değiştirilemez
(PL)	Źródło światła nie jest wymienne
(GR)	Οι λαμπτήρες δεν αντικαθίστανται
(RUS)	Светодиоды не поддаются замене
(JAE)	تجهيزات الإضاءة غير قابلة للاستبدال

	AC 230V / 50-60 Hz	13,5W	LED / 2700K / 1200lm / CRI >90
(D)	Spannung	Belastung	Lampe
(GB)	Voltage	Loading	Bulb
(NL)	Spanning	Belasting	Verlichtingsmiddel
(F)	Tension	Charge	Ampoule
(I)	Tensione	Carico	Sorgente luminosa
(ES)	Tensión	Carga	Lámpara
(P)	Tensão	Carga	Lâmpada
(DK)	Spænding	Belastning	Pære
(S)	Spänning	Belastning	Ljuskälla
(N)	Spenning	Fatning	Lampe
(FI)	Jännite	Kuormitus	Lamppu
(TR)	Gerilim	Yük	Lamba
(PL)	Napięcie	Oprawka	Lampa
(GR)	Τάση	Υποδοχή	Λαμπτήρας
(RUS)	Напряжение	Нагрузка	Лампочка
(JAE)	الجهد الكهربى	الدواة	المصباح

	
	
IEC 62471 (EN 62471) <b>RG1 - LOW RISK</b>	
	
	

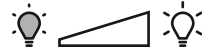
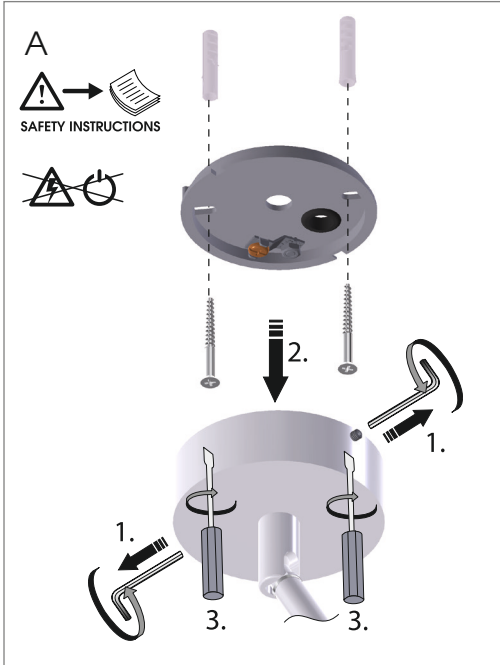

empfohlene Dimmer  
recommended dimmers

- Busch-Jaeger 6523U-102
- Busch-Jaeger 2247
- Merten SBD600RL
- Merten 572599
- Kopp 8068
- Sygonix 33595Q
- Zano WH250
- Casambi CBU-TED\*
- Homematic HM-LC-Dim1T-CV\*
- Homematic HM-LC-Dim1T-FM\*
- Homematic HM-LC-Dim1TPBU-FM\*
- Homematic IP HmiP-FDT\*
- Homematic IP HmiP-BDT\*

\* Mindestdimmwert : Casambi = 22% / Homematic = 26% / Homematic IP = 30%  
Minimum dim value : Casambi = 22% / Homematic = 26% / Homematic IP = 30%

Alle Angaben ohne Gewähr und ohne Anspruch auf Vollständigkeit. Bitte beachten Sie die Herstellerangaben.  
No guarantee on correctness and completeness of informations. Please comply with the relevant manufacture's recommendations.

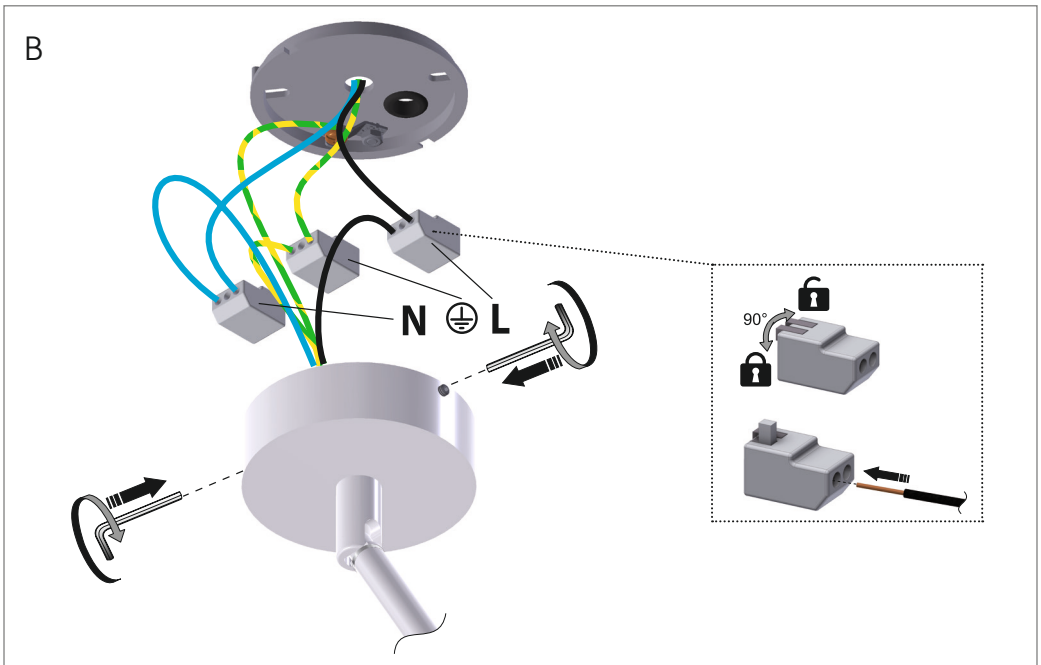

## SCOTTY CEILING

OLIGO Lichttechnik GmbH  
Tannenweg 1  
DE - 53757 Sankt Augustin  
Germany  
www.oligo.de  
info@oligo.de







Art.-Nr. / Item-No.  
**41-859-XX-YY**

Dieses Produkt enthält Lichtquelle/n des Typs Seoul Semiconductors, SMJE-3D12W4PE der Energieeffizienzklasse F.

(D)	Leuchtmittel nicht ersetzbar
(GB)	Bulbs not replaceable
(NL)	Lamp niet vervangbaar
(F)	Ampoules non remplaçables
(I)	Lampadina non sostituibile
(ES)	Bombillas no reemplazables
(P)	Lâmpada não substituível
(DK)	Ljuskällorna kan inte bytas ut

(S)	Bulb inte utbytbara
(N)	Lyspærer kan ikke skiftes ut
(FI)	Valistusvälinettä ei voi vaihtaa
(TR)	Ampuller değiştirilemez
(PL)	Źródło światła nie jest wymienne
(GR)	Οι λαμπτήρες δεν αντικαθίστανται
(RUS)	Светодиоды не поддаются замене
(JAE)	تجهيزات الإضاءة غير قابلة للاستبدال

	AC 230V / 50-60 Hz	13,5W	LED / 2700K / 1200lm / CRI >90
(D)	Spannung	Belastung	Lampe
(GB)	Voltage	Loading	Bulb
(NL)	Spanning	Belasting	Verlichtingsmiddel
(F)	Tension	Charge	Ampoule
(I)	Tensione	Carico	Sorgente luminosa
(ES)	Tensión	Carga	Lámpara
(P)	Tensão	Carga	Lâmpada
(DK)	Spænding	Belastning	Pære
(S)	Spänning	Belastning	Ljuskälla
(N)	Spenning	Fatning	Lampe
(FI)	Jännite	Kuormitus	Lamppu
(TR)	Gerilim	Yük	Lamba
(PL)	Napięcie	Oprawka	Lampa
(GR)	Τάση	Υποδοχή	Λαμπτήρας
(RUS)	Напряжение	Нагрузка	Лампочка
(JAE)	الجهد الكهربى	الدواة	المصباح

	
	
IEC 62471 (EN 62471) <b>RG1 - LOW RISK</b>	
	
	

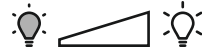
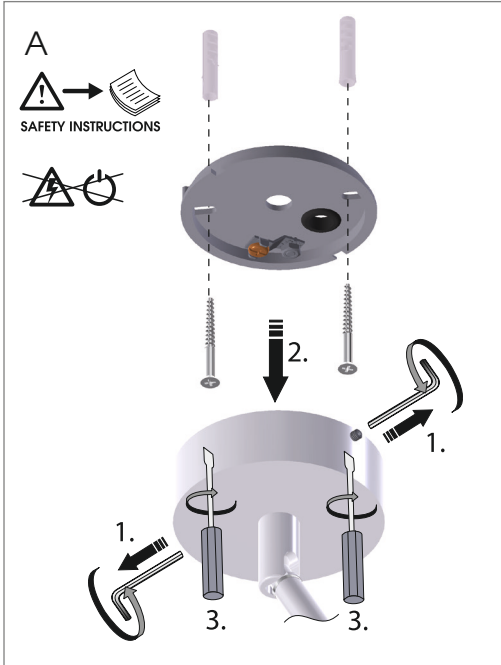

empfohlene Dimmer  
recommended dimmers

- Busch-Jaeger 6523U-102
- Busch-Jaeger 2247
- Merten SBD600RL
- Merten 572599
- Kopp 8068
- Sygonix 33595Q
- Zano WH250
- Casambi CBU-TED\*
- Homematic HM-LC-Dim1T-CV\*
- Homematic HM-LC-Dim1T-FM\*
- Homematic HM-LC-Dim1TPBU-FM\*
- Homematic IP HmiP-FDT\*
- Homematic IP HmiP-BDT\*

\* Mindestdimmwert : Casambi = 22% / Homematic = 26% / Homematic IP = 30%  
Minimum dim value : Casambi = 22% / Homematic = 26% / Homematic IP = 30%  
Alle Angaben ohne Gewähr und ohne Anspruch auf Vollständigkeit. Bitte beachten Sie die Herstellerangaben.  
No guarantee on correctness and completeness of informations. Please comply with the relevant manufacture's recommendations.

