

Flo Wall M

design Foster + Partners, 2013

release 2019, December

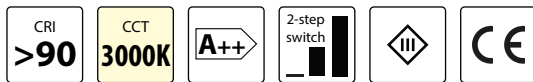



LED wall lamp, in varnish coated aluminium and steel.
 Head rotates by 300°, arm pivots by 90°+ 90°.
 3W-LED which you can switch on with one click for full light intensity, with two clicks for half light intensity. Without feeder

Finishing

Standard

 Black soft touch
 cod. 97601ST00

 Matt white
 cod. 97602OP00

 Brushed nickel
 cod. 9764400

Special

 Matt red
 cod. 97603OP00

 Matt yellow
 cod. 97605OP00

 Metallic bronze
 cod. 97629MT00

 Gunmetal
 cod. 9763200

All RAL coating and galvanic finishes available upon request

Light emission

- Light emission: diffuse
- Light direction: downlight
- Light source: led board
- Source flux: 270 lm
- Emitted flux: 150 lm
- Efficacy: 30 lm/W
- CCT: 3000K
- CRI index: >90
- Lifetime: >55000h L80 @ 25°C

Electrical Facts

- Source power: 3 W
- Power absorption: 5 W
- Stand-by absorption: < 1 W
- Grid voltage: according to power supply data
- Power supply: 24V AC-DC supply required
- Dimmability: internal push dimmer
- Energy class: A++

Technical data

- Environment: indoor
- Placement: wall
- Net weight: 0,55 Kg
- Certifications: CE
- Suggested ambient T: 25°C
- Maximum ambient T: 40°C
- Insulation class: III
- Protection class: IP20

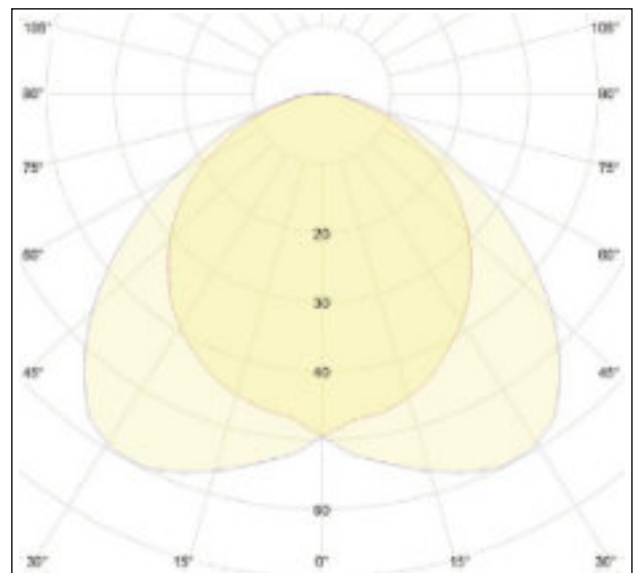
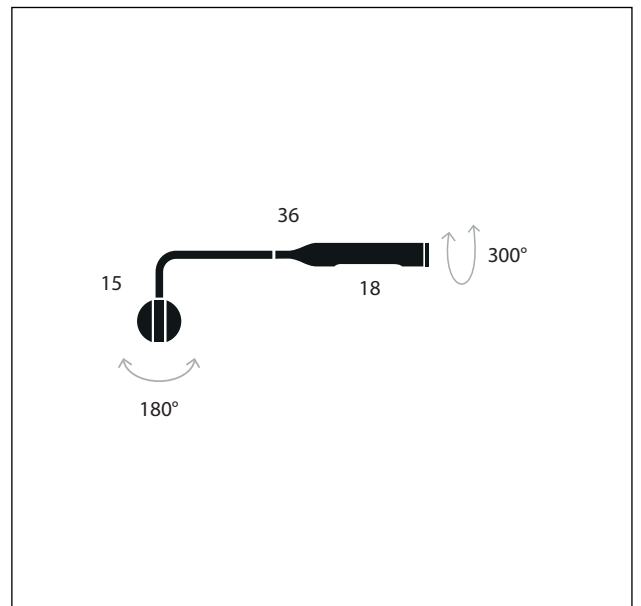
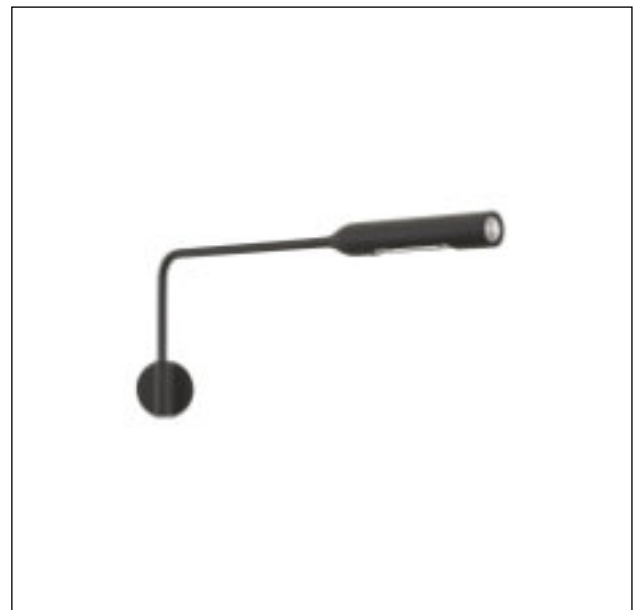

Packaging
 cardboard box
 50 x 31 x 8 (cm)
 0,012 m³

Gross weight
 1,1 Kg

Flo Wall M

design Foster + Partners, 2013

release 2019, December

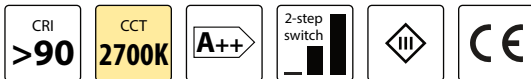

LED wall lamp, in varnish coated aluminium and steel.
 Head rotates by 300°, arm pivots by 90°+ 90°.
 3W-LED which you can switch on with one click for full light intensity, with two clicks for half light intensity. Without feeder

Finishing

Standard

● Black soft touch
 cod. 97601STK27

○ Matt white
 cod. 97602OPK27

● Brushed nickel
 cod. 97644K27

Special

● Matt red
 cod. 97603OPK27

● Matt yellow
 cod. 97605OPK27

● Metallic bronze
 cod. 97629MTK27

● Gunmetal
 cod. 97632K27

All RAL coating and galvanic finishes available upon request

Light emission

- Light emission: diffuse
- Light direction: downlight
- Light source: led board
- Source flux: 250 lm
- Emitted flux: 140 lm
- Efficacy: 28 lm/W
- CCT: 2700K
- CRI index: >90
- Lifetime: >55000h L80 @ 25°C

Electrical Facts

- Source power: 3 W
- Power absorption: 5 W
- Stand-by absorption: < 1 W
- Grid voltage: according to power supply data
- Power supply: 24V AC-DC supply required
- Dimmability: internal push dimmer
- Energy class: A++

Technical data

- Environment: indoor
- Placement: wall
- Net weight: 0,55 Kg
- Certifications: CE
- Suggested ambient T: 25°C
- Maximum ambient T: 40°C
- Insulation class: III
- Protection class: IP20

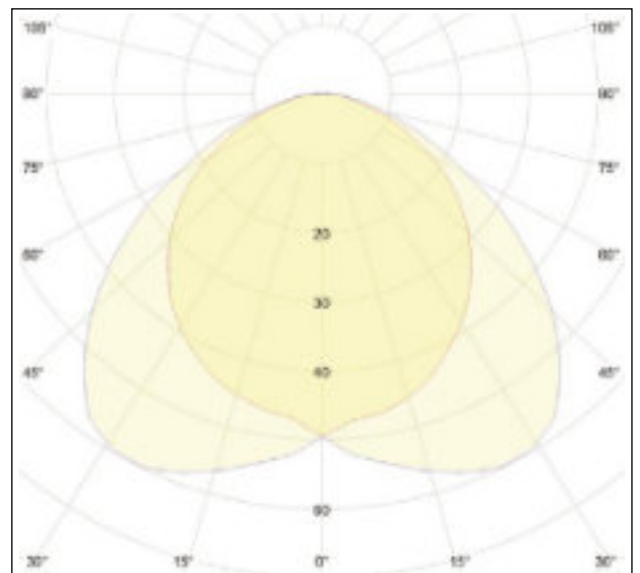
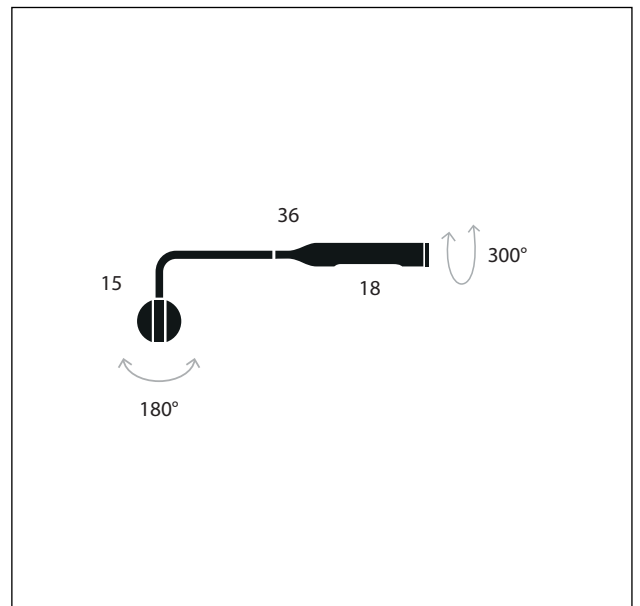

Packaging
 cardboard box
 50 x 31 x 8 (cm)
 0,012 m³

Gross weight
 1,1 Kg